

# XSOLO

ULTRA-COMPACT, HIGH-EFFICIENCY 500 W AND 1000 W SINGLE OUTPUT POWER SUPPLIES

Advanced Energy's Xsolo series, part of our low voltage solutions, delivers an incredible convection-cooled 504 W in an open-frame U-channel form factor and up to 1008 W in an enclosed, fan-cooled chassis. This high-efficiency, high-reliability product is available in two compact package types.



## PRODUCT HIGHLIGHTS

- Single output voltages are 24 V, 36 V, or 48 V with wide adjustment ranges and user-defined set-points
- Ultra high efficiency, > 92%
- Low profile: 1U height (40 mm)
- Convection-cooled 500 W
- Fan-cooled 1000 W (variable speed fan)
- 12 V/300 mA bias standby voltage provided
- Remote ON/OFF signal
- Power Good signal
- Suitable for type B-rated applications
- Optional I<sup>2</sup>C PMBus™ communications
- Optional OR-ing function
- Five-year warranty
- Adjustable output voltage control

- 5000 m altitude for EN60950 applications
- All models feature active power factor correction as standard
- Product options: Conformal coating, low leakage current and ruggedized

## TYPICAL APPLICATIONS

- Industrial
- Test and measurement
- Acoustically sensitive laboratory and medical environments
- Hi-Rel MIL-COTS
- Communication

## AT A GLANCE

	XS500	XS1000
<b>Power</b>	504 W	1008 W
<b>Output Voltage</b>	24, 36, 48	24, 36, 48
<b>Certifications</b>	<ul style="list-style-type: none"> <li>■ IEC60601-1 2nd and 3rd edition</li> <li>■ IEC60601-1-2 4th edition (EMC)</li> <li>■ IEC60950 2nd edition</li> <li>■ 2 MOPP</li> <li>■ SEMI F47</li> <li>■ MIL-STD-810G</li> </ul>	

MODELS

Model	Power (W)	Output Voltage	Output Current (A)	Medical Approval UL/EN60601-1, 3rd Edition	Industrial Approval UL/EN60950, 2nd Edition
XS500-24	504	24	21.0	Yes	Yes
XS1000-24	1008	24	42.0	Yes	Yes
XS500-36	504	36	14.0	Yes	Yes
XS1000-36	1008	36	28.0	Yes	Yes
XS500-48	504	48	10.5	Yes	Yes
XS1000-48	1008	48	21.0	Yes	Yes

Model	Vnom (W)	Description	Set Point Adjust Range (V)	Dynamic Vtrim Range (V)	I <sub>max</sub> (A)	Remote Sense	Power Good
XS500-24	24	Convection-cooled U-channel	19-28	14-28	21.0	Yes	Yes
XS1000-24	24	Enclosed fan-cooled	19-28	14-28	42.0	Yes	Yes
XS500-36	36	Convection-cooled U-channel	26-40	20-40	14.0	Yes	Yes
XS1000-36	36	Enclosed fan-cooled	26-40	20-40	28.0	Yes	Yes
XS500-48	48	Convection-cooled U-channel	36-58	39-58	10.5	Yes	—
XS1000-48	48	Enclosed fan-cooled	36-58	29-58	21.0	Yes	Yes

ELECTRICAL SPECIFICATIONS

Input					
Parameter	Conditions/Description	Min	Nom	Max	Units
Input Voltage Range	Universal input 47-440 Hz	85	—	264	VAC
	—	120	—	380	VDC
Power Rating	XS500	—	504	—	W
	XS1000	—	1008	—	W
Input Current	XS500	—	5	—	A
	XS1000	—	10	A	—
Inrush Current	230 VAC @ 25°C	—	—	25	A
Undervoltage Lockout	Shutdown	65	—	74	VAC
Fusing	XS500 250 VAC	—	F8A HRC	—	—
	XS1000 250 VAC	—	F12A HRC	—	—

Output					
Parameter	Conditions/Description	Min	Nom	Max	Units
Output Voltage Range	XS500/1000-24: Multi-turn potentiometer	19	—	28	VDC
	XS500/1000-24: Dynamic Vtrim range	14	—	28	VDC
	XS500/1000-36: Multi-turn potentiometer	26	—	40	VDC
	XS500/1000-36: Dynamic Vtrim range	20	—	40	VDC
	XS500/1000-48: Multi-turn potentiometer	36	—	58	VDC
	XS500/1000-48: Dynamic Vtrim range	29	—	58	VDC

## ELECTRICAL SPECIFICATIONS (CONTINUED)

Output (Continued)					
Parameter	Conditions/Description	Min	Nom	Max	Units
Output Current Range	XS500-24	—	—	21	A
	XS1000-24	—	—	42	A
	XS500-36	—	—	14	A
	XS1000-36	—	—	28	A
	XS500-48	—	—	10.5	A
	XS1000-48	—	—	21	A
Load and Cross Regulation	For 25% to 75% load change	—	—	±0.2	%
	ORing option	—	—	±0.4	%
Transient Response	For 25% to 75% load change voltage deviation	—	—	2.5	%
	Settling time	—	—	500	µs
Ripple and Noise	XS500/1000-24: 20 MHz	—	240	—	mV pk-pk
	XS500/1000-36: 20 MHz	—	360 mV	—	pk-pk
	XS500/1000-48: 20 MHz	—	480	—	mV pk-pk
Overvoltage Protection	XS500/1000-24: Latching	33	34	37	VDC
	XS500/1000-36: Latching	44	47	52	VDC
	XS500/1000-48: Latching	61	63	69	VDC
Overcurrent Protection	Straight line with hiccup activation at < 30% of Vnom.	105	115	130	%
Line Regulation	For ±10% change from nominal line	—	±0.5	—	%
Remote Sense	—	—	—	0.5	VDC
Overshoot	—	—	—	2	%
Rise Time	Monotonic	—	3	5	ms
Turn-On Delay	From AC in	—	500	800	ms
	From remote On/Off	—	10	—	ms
Hold-Up Time	For nominal output voltages at full load.	17	—	—	ms

General					
Parameter	Conditions/Description	Min	Nom	Max	Units
Isolation Voltage	Input to output	4000	—	—	VAC
	Input to chassis	1500	—	—	VAC
	Output to chassis	1500	—	—	VAC
Efficiency	230 VAC, 1008 W @ 24 V/36 V/48 V	—	> 92	—	%
Safety Agency Approvals	EN60601-1 2nd and 3rd Edition, cTUVus 60601-1	—	—	—	—
	EN60950 2nd Edition, cTUVus 60950	—	—	—	—
Leakage Current	264 VAC, 60 Hz, 25°C	—	—	300	µA
	264 VAC, 60 Hz, 25°C (Option 4)	—	—	150	µA
Signals	See the designer's manual	—	—	—	—
Bias Supply	Always on, current 300 mA XS1000, 50 mA XS500	—	12.0	—	VDC
Weight	XS500	—	1.1	—	Kg
	XS1000	—	1.3	—	Kg
MTBF	Telecordia SR-332, 40°C ground benign, parts count	—	—	550,000	Hours

ELECTRICAL SPECIFICATIONS (CONTINUED)

EMC		
Parameter	Standard	Level
<b>Emissions</b>		
Conducted	EN55011, EN55022, FCC	Class B
Radiated	EN55011, EN55022, FCC	Class B
Harmonic Distortion	EN61000-3-2 Class A	Compliant
Flicker and Fluctuation	EN61000-3-3	Compliant
<b>Immunity</b>		
Electrostatic Discharge	EN61000-4-2	Level 2
Radiated Immunity	EN61000-4-3	Level 3
Fast Transients-Burst	EN61000-4-4	Level 3
Input Line Surges	EN61000-4-5	Level 3
Conducted Immunity	EN61000-4-6	Level 3
Voltage Dips	EN61000-4-11, SEMI F47 compliant <sup>1</sup>	Compliant

Environmental						
Parameter	Conditions/Description	Min	Nom	Max	Units	
Operating Temperature	-40	—	+70	—	°C	
Storage Temperature	-40	—	+85	—	°C	
Derating	See the designer's manual for full temperature deratings	—	—	—	—	
Relative Humidity	Non-condensing	5	—	95	%RH	
Shock and Vibration	Designed to meet MIL810 G <sup>2</sup>	—	55	—	G	
Altitude	EN60601-1 Operational: 3000 m, Storage 8000 m	—	3000	—	m	
	EN60950 Operational: 5000 m, Storage 8000 m	—	5000	—	m	

Derating Curves

The line voltage and temperatures derating curves for the XS500 and XS1000 are shown below. The XS500 is a 500 W convection-cooled part. The graphs below show the output power ratings with no system air flow and with 10 CFM of system air flow applied to the product.

Contact Advanced Energy for further information on the XS500 and XS1000 performance with system air flow applied to the product.

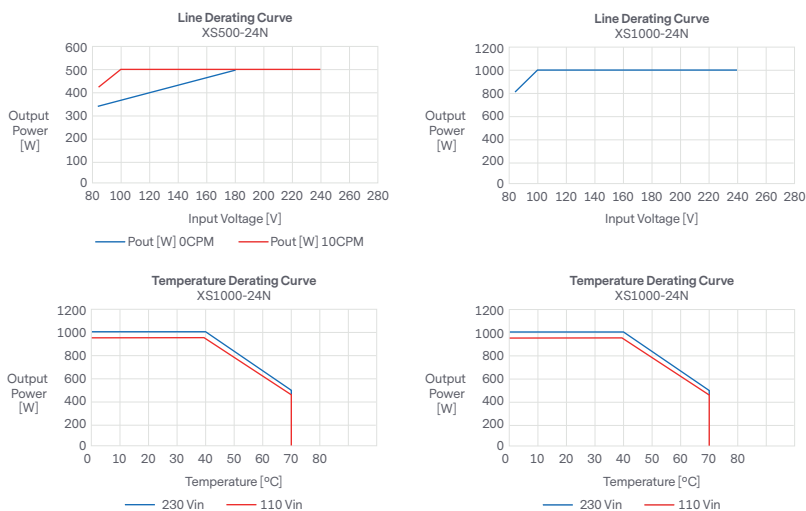

**INTERFACE**

**Input Connector J7**

Connector, Barrier Terminal Block, Vertical, 3 position, Pitch: 0.375 in Molex — 38720-7503

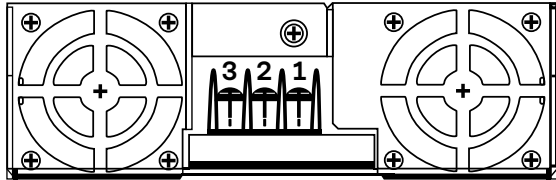

**O/P Connector J10 and J12**

Connector, Barrier STRIP DL 3CIRC .325 Tyco — 2-1437667-5

\*Note: Maximum current per screw terminal is 20 Amps

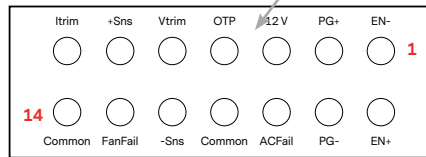
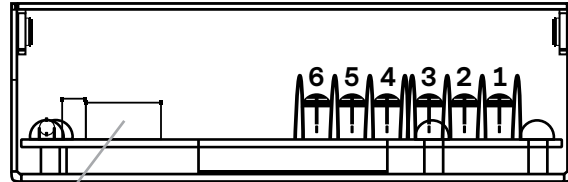

**Output Signal Connector J5**

Connector, Header 14POS 2MM Pitch T/H Molex — 87831-1420

**J5 Mating Connectors**

Locking Molex 51110-1451;  
Non Locking 51110-1450;  
Crimp Terminal: Molex p/n 50394

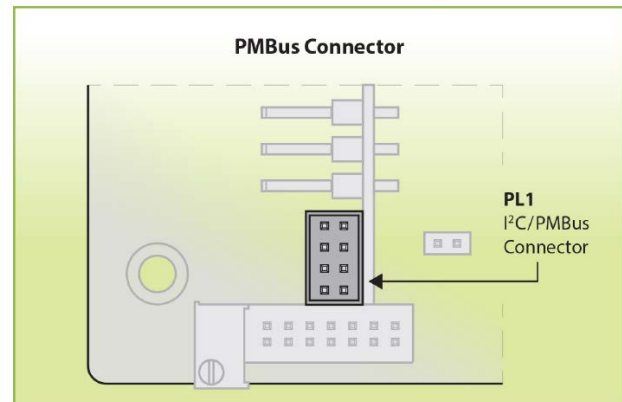

**I²C Interface (Option)**

The I²C PMBus™ compatible interface can be used for monitoring the output voltage and current. It can also be used to manage real time data for the PSU. For full details on PMBus™ please contact Advanced Energy.

**PMBus™ Connector**

PL1: Molex — 87833-0831

**PL1 Mating Connector**

Locking Molex 51110-0860;  
Non Locking 51110-0850;  
Crimp Terminal: Molex p/n 50394

Connector Details				
Pin	Input	Output	Signal	PMBus Connector
1	L	+Vo	EN-	Not Used
2	N	+Vo	EN+	GND
3	PE	+Vo	PG+	Not Used
4	—	-Vo	PG-	Not Used
5	—	-Vo	12V	SCL
6	—	-Vo	ACFail	Not Used
7	—	—	OTP	Not Used
8	—	—	Common	SDA
9	—	—	Vtrim	—
10	—	—	-Sns	—
11	—	—	+Sns	—
12	—	—	FanFail	—
13	—	—	Itrim	—
14	—	—	Common	—

## XSOLO SERIES

### Paralleling Xsolo Products

To achieve increased currents Xsolo products can be paralleled. To connect in parallel the outputs must be trimmed to within 5 mV of each other and then the current share header J20 must be added to each Xsolo product.

- Recommended Jumper for J20: HARWIN M7567-05
- (Jumper Socket, Black, 2.54 mm, 2-way)

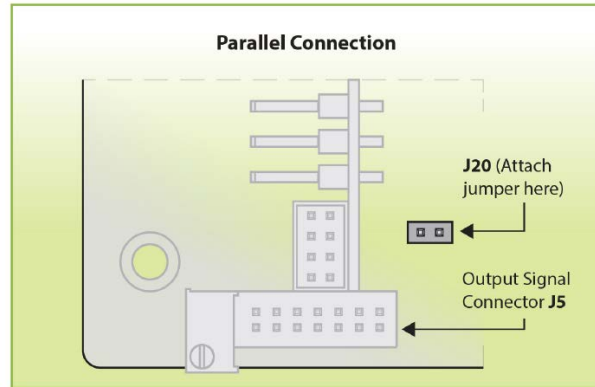

## MECHANICAL SPECIFICATIONS

### XSS500-24

(All dimensions in mm)

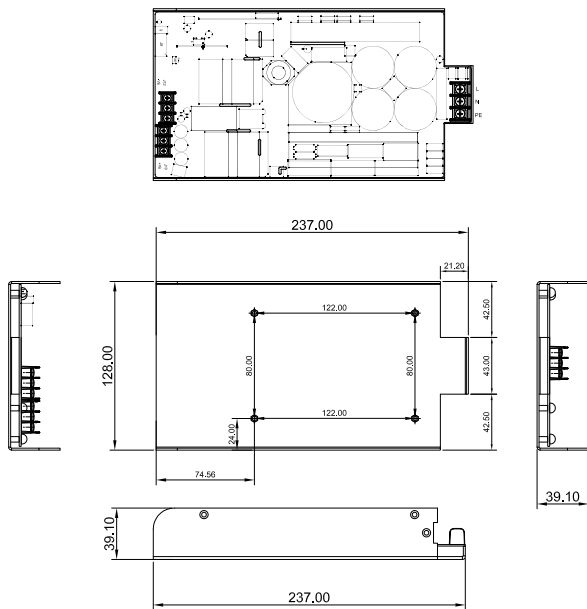

#### Mounting Holes

4 M4 threaded PEMS on Base, Max Screw Penetration is 6 mm from Base

#### NOTES

- <sup>1</sup> SEMI F47 compliant at input voltages > 160 VAC. Consult Advanced Energy for details.
- <sup>2</sup> Consult Advanced Energy for HALT report (enhanced ruggedisation available as an option).
- <sup>3</sup> System design with low leakage capacitors requires particular attention to EMI. Please consult Advanced Energy for application details.
- <sup>4</sup> Contact Advanced Energy for details including MOQs on alternative preset output voltages.
- <sup>5</sup> The specifications contained herein are believed to be correct at time of publication and are subject to change without notice.
- <sup>6</sup> All specifications at nominal input, full load, 25°C unless otherwise stated.
- <sup>7</sup> Compliance with MIL-STD-461 (CE101 & CE102) achieved with the addition of an external line filter from LCR p/n F19374.
- <sup>8</sup> Product is not UL/EN certified for 120-380 VDC input operation. Consult Advanced Energy for details.
- <sup>9</sup> Above 2000 m altitude, ambient operating temperature decreases by 1°C per 305 m (1000 ft) altitude increase

### XSS1000-24

(All dimensions in mm)

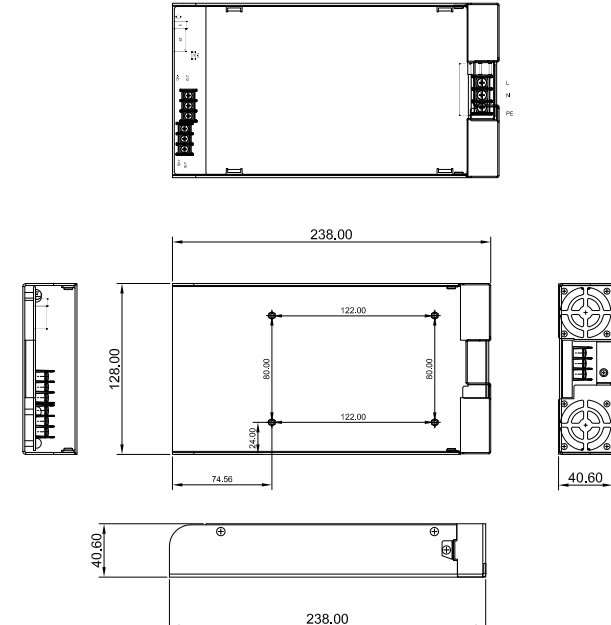

#### Mounting Holes

4 M4 threaded PEMS on Base, Max Screw Penetration is 6 mm from Base

CONFIGURATION

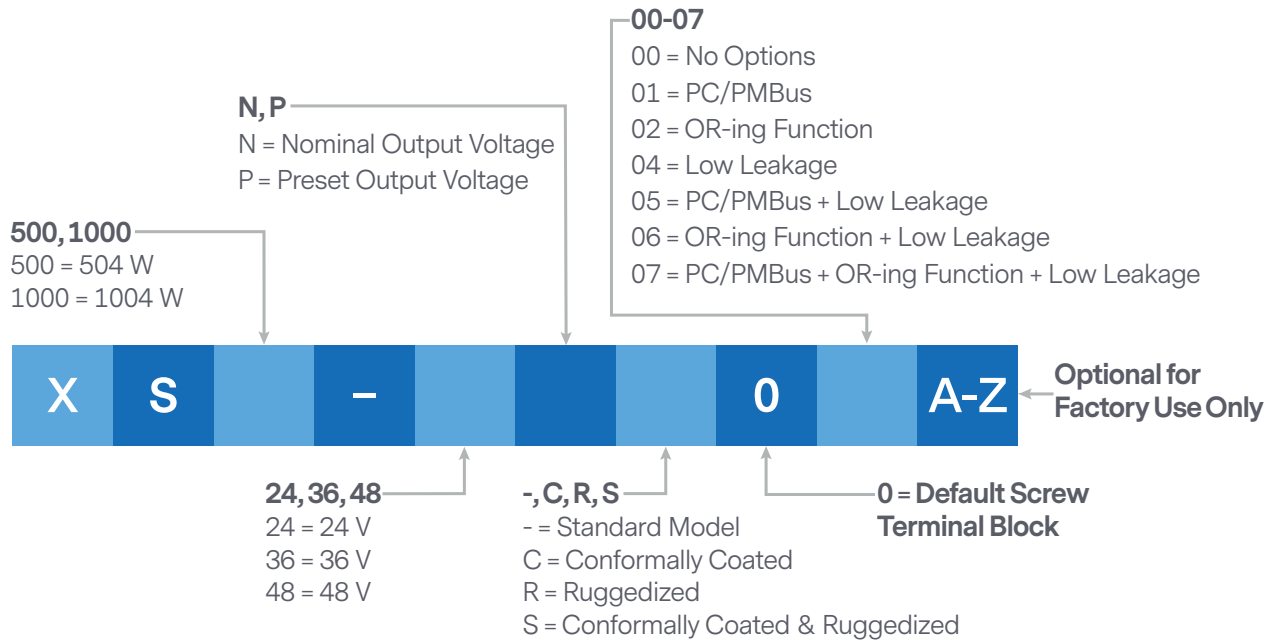

**Example 1:** XS1000-24N-000 = Xsolo 1000 W, 24 V, output with no options

**Example 2:** XS1000-24N-003 = Xsolo 1000 W, 24 V, output with PC/PMBus and OR-ing function



## ABOUT ADVANCED ENERGY

Advanced Energy (AE) has devoted more than three decades to perfecting power for its global customers. AE designs and manufactures highly engineered, precision power conversion, measurement and control solutions for mission-critical applications and processes.

AE's power solutions enable customer innovation in complex semiconductor and industrial thin film plasma manufacturing processes, demanding high and low voltage applications, and temperature-critical thermal processes.

With deep applications know-how and responsive service and support across the globe, AE builds collaborative partnerships to meet rapid technological developments, propel growth for its customers and power the future of technology.

## PRECISION | POWER | PERFORMANCE



For international contact information, visit [advancedenergy.com](http://advancedenergy.com)

Specifications are subject to change without notice. Not responsible for errors or omissions. ©2019 Advanced Energy Industries, Inc. All rights reserved. Advanced Energy® and AE® are U.S. trademarks, and CoolX® is a U.S. and European trademark of Advanced Energy Industries, Inc.

